



EPLAN P8

Elektrodokumentation

Electrical documentation

Hersteller:
Manufacturer: Boll & Kirch Filterbau GmbH
Siemensstraße 10-14
50170 Kerpen

Algemeine Daten:
General informations:

BK-Artikel-Nr.: 4302300
BK-Article-No.:

Projektdate:
Project data:

Zeichnungs-Nr.: Z46603
Drawing-No.:

Typ: Filtertyp 6.60.07/6.60.07 Alarm DP
Type: Filter type 6.60.07/6.60.07 Alarm DP

Bezeichnung: Vollautomatischer Rückspülfilter
Designation: Fully automatic back flushing filter

Anzahl Seiten: 15
Number of pages:

Bearbeiter: gruenwald
Edited by:

Datum: 16.05.2019
Date:

Normen:
Specifications: Ausführung der Schaltanlage nach DIN VDE 0660 Teil 5 bzw. IEC 439. Bestimmungen für fabrikfertige Schaltgerätekombinationen mit Nennspannung bis 750V. Nennisolationsspannung 450/750V und Nennspannung 450/750V. Execution of the switchgear according to DIN VDE 0660 part 5 or IEC 439. Regulations for factory-fabricated switchgear combinations with rated voltage up to 750V. Rated insulation voltage 450/750V and rated voltage 450/750V.

Technische Kenngrößen
Technical characteristics

Gehäuse:
Housings:

Bezeichnung: EB 1555.500
Designation:

Materialtyp: Stahlblech
Material: Carbon steel

Abmessungen: 300 x 300 x 120mm
Dimensionings:

Schutzart: IP65
Degree of protection:

Farbe: RAL7035
Color:

Türanschlag: Rechts
Door stop: Right

Montage: Wandabstandshalter
Mounting: Wall spacer

Gewicht: 15kg
Weight:

Leitungsfarben:
Wire colors:

Arbeitsstromkreis: Schwarz
Load circuit: Black

Schutzleiter: Grün/Gelb
PE conductor: Green/Yellow

Steuerstromkreis: Rot
Control circuit: Red

Fremdspannung: Orange
External voltage: Orange

Verdrahtung
Wiring

Hauptstromkreis wird mit 1,5mm² und Steuerstromkreis mit 1mm² verlegt. Die Verdrahtung erfolgt von oben nach unten bzw. von links nach rechts gemäß den Stromlaufplänen. The main circuit is laid with 1.5mm² and the control circuit with 1mm². The wiring is carried out from top to bottom or from left to right according to the circuit diagrams.

Spannungen:
Voltages:

Betriebsspannung: 3~/PE
Operating voltage: 230-575V +/- 5%

Frequenz: 50/60Hz
Frequency:

Steuerspannung: 230V AC
Control voltage: 115V AC
24V DC

Sonstiges:
Miscellaneous:

Aderbeschriftung: -
Wire labeling:

Kabeltyp: H07V-K
Cable type:

Netzform: TN
Network types:

Umgebungstemperatur: 55°C
Environment temperature:

Kurzschlussfestigkeit (SCCR): 50kA
Short-circuit strength (SCCR):

Steuergerät: BK2300
Control device:

Getriebemotorleistung: 0,09 - 0,18kW
Gear motor power:

weitere Hinweise:
other notes:

Kabeleinführung: Cable entry:

oben top unten bottom

Hauptschalter: Main switch:

vorne Front

links left

rechts right

Kundenvorschriften: Customer specifications:

Ja Yes Nein No

		Datum Date	16.05.2019		Hersteller Manufacturer	Deckblatt Cover sheet	BK-Artikel-Nr.: 4302300	=	
		Bearbeiter Edited by	gruenwald		Boll & Kirch Filterbau GmbH	Filtertyp 6.60.07/6.60.07 Alarm DP Filter type 6.60.07/6.60.07 Alarm DP	BK-Artikel-No.:	+	
		Auftrag Order					Zeichnungs-Nr.: Z46603	Blatt Page	1
Revision Modification	Bearbeiter Edited by	Datum Date	Vorgang Process				Drawing-No.:	von of	15

Inhaltsverzeichnis

Table of contents

Anlage Plant	Einbauort Mounting location	Dokumentenart Document type	Seite Page	Seitenbezeichnung Page designation	Datum Date	Bearbeiter Edited by
		Schaltplan Wiring diagram	1	Deckblatt Cover sheet	11.07.2019	gruenwald
		Schaltplan Wiring diagram	2	Inhaltsverzeichnis Table of contents	11.07.2019	gruenwald
		Schaltplan Wiring diagram	3	Einspeisung und Stromversorgung Feed-in and power supply	05.07.2019	gruenwald
		Schaltplan Wiring diagram	4	Platine Circuit board	10.07.2019	gruenwald
		Schaltplan Wiring diagram	5	Getriebemotor Gear motor	03.07.2019	gruenwald
		Schaltplan Wiring diagram	6	Bedienfeld Control panel	03.07.2019	gruenwald
		Schaltplan Wiring diagram	7	Aufbauplan Assembling diagram	11.07.2019	gruenwald
		Materialliste Part list	8	Materialliste Part list	11.07.2019	gruenwald
		Materialliste Part list	9	Materialliste Part list	11.07.2019	gruenwald
		Klemmenplan Terminal diagram	10	Klemmenplan Terminal diagram	11.07.2019	gruenwald
		Klemmenplan Terminal diagram	11	Klemmenplan Terminal diagram	11.07.2019	gruenwald
		Klemmenplan Terminal diagram	12	Klemmenplan Terminal diagram	11.07.2019	gruenwald
		Klemmenplan Terminal diagram	13	Klemmenplan Terminal diagram	11.07.2019	gruenwald
		Klemmenplan Terminal diagram	14	Klemmenplan Terminal diagram	11.07.2019	gruenwald
		Klemmenplan Terminal diagram	15	Klemmenplan Terminal diagram	11.07.2019	gruenwald

		Datum Date	16.05.2019		Hersteller Manufacturer	Inhaltsverzeichnis Table of contents	BK-Artikel-Nr.: 4302300	=	
		Bearbeiter Edited by	gruenwald				+ Blatt Page	2	
		Auftrag Order					Zeichnungs-Nr.: Z46603 Drawing-No.:	von of	15
Revision Modification	Bearbeiter Edited by	Datum Date	Vorgang Process						

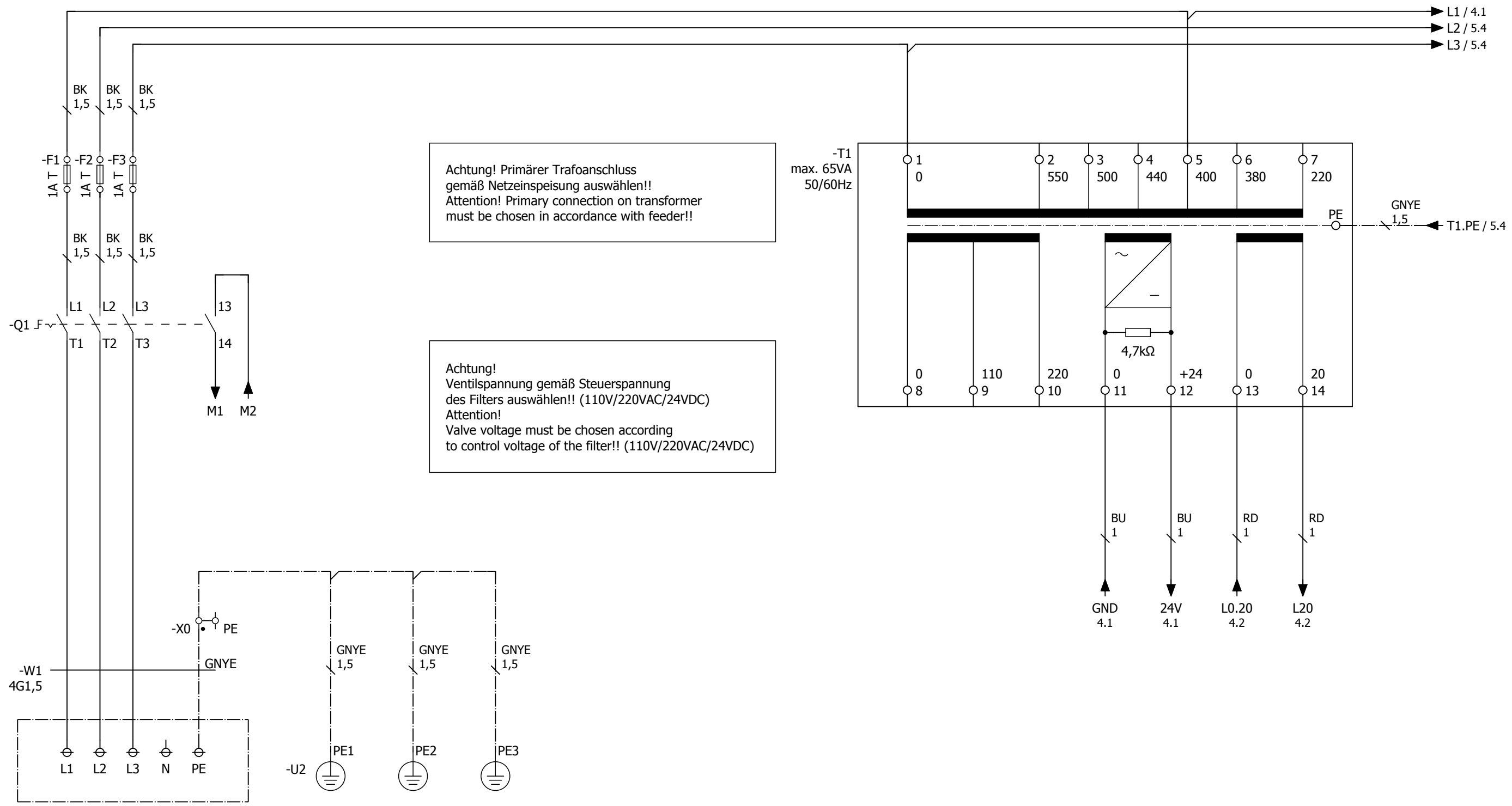

Achtung! Primärer Trafoanschluss gemäß Netzeinspeisung auswählen!!
 Attention! Primary connection on transformer must be chosen in accordance with feeder!!

Achtung! Ventilspannung gemäß Steuerspannung des Filters auswählen!! (110V/220VAC/24VDC)
 Attention! Valve voltage must be chosen according to control voltage of the filter!! (110V/220VAC/24VDC)

Spannung: 230...575V
 Voltage:
 Frequenz: 50/60Hz
 Frequency:
 max. Vorsicherung: Kundenseitig
 max. Pre-protection: by customer

Einspeisung vom Netz
 Power supply input from mains

Alle nicht bezeichneten Leitungen = 1mm²
 All unnamed leads = 1mm²

			Datum Date	16.05.2019		Hersteller Manufacturer Boll & Kirch Filterbau GmbH	Einspeisung und Stromversorgung Feed-in and power supply Filtertyp 6.60.07/6.60.07 Alarm DP Filter type 6.60.07/6.60.07 Alarm DP	BK-Artikel-Nr.: 4302300	=
			Bearbeiter Edited by	gruenwald				BK-Article-No.: 4302300	
Revision Modification	Bearbeiter Edited by	Datum Date	Auftrag Order						
			Vorgang Process				Drawing-No.: Z46603	von of	15

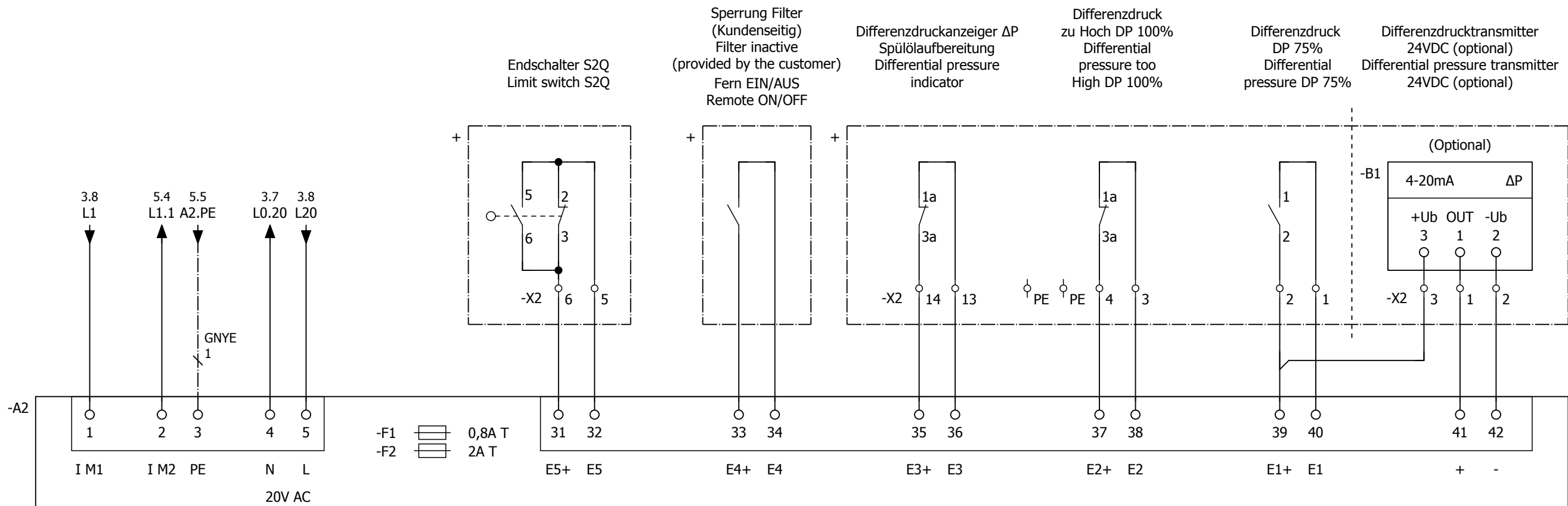

Bei Verwendung Differenzdrucktransmitter (DPT) entfällt der Differenzdruckschalter (DPS).
If differential pressure transmitter is used, the differential pressure switch is not required.

BOLL & KIRCH BK2300

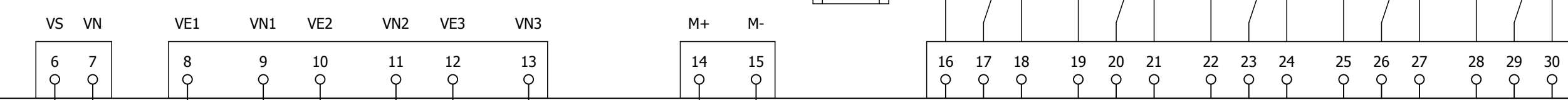

Steuerspannung Magnetventil
-Y1/-Y2/-Y3
(24VDC/115VAC/230VAC)
Control voltage solenoid valve
-Y1/-Y2/-Y3
(24VDC/115VAC/230VAC)

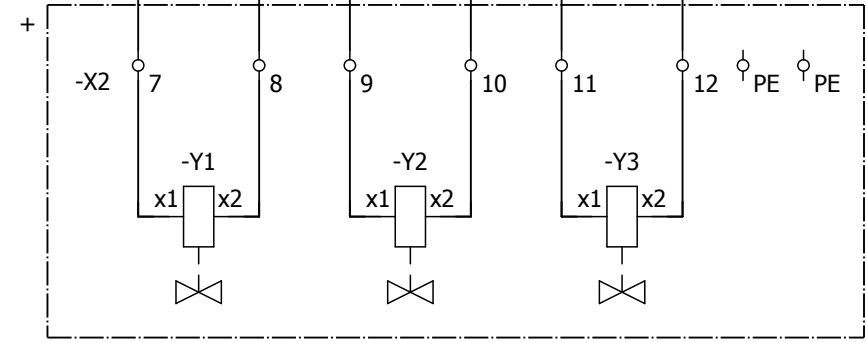

- 1 - 2 /5.4
- 3 - 4 /5.4
- 5 - 6 /5.4
- 13 - 14

Spülventil Flushing valve
Kammerventil Chamber valve
Nachblaseventil Afterblowing valve
Netzschütz Mains contactor

Alarm potentialfrei
Steuerspannungsüberwachung
Fault potential-free
control voltage monitoring

Sammelstörung potentialfreie
max. Differenzdruck erreicht Alarm Patrone.
General fault potential-free
max. difference pressure obtained Alarm cartridge.

Alarm potentialfrei Rückspülauslösung durch
Differenzdruck
Alarm potentialfree back flushing triggered by
pressure differential

Spülen aktiv
Flushing active

Sperrung Filter
Filter inactive

Alle nicht bezeichneten
Leitungen = 1mm²
All unnamed leads = 1mm²

			Datum Date	16.05.2019		Hersteller Manufacturer	Platine Circuit board	BK-Artikel-Nr.: BK-Article-No.:	4302300	=		
			Bearbeiter Edited by	gruenwald		Boll & Kirch Filterbau GmbH	Filtertyp 6.60.07/6.60.07 Alarm DP Filter type 6.60.07/6.60.07 Alarm DP			+		
			Auftrag Order								Blatt Page	4
Revision Modification	Bearbeiter Edited by	Datum Date	Vorgang Process						Zeichnungs-Nr.: Drawing-No.:	Z46603	von of	15

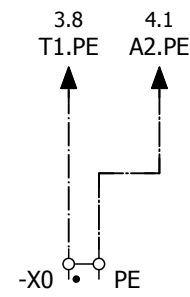
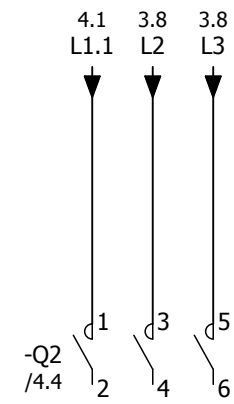

Achtung:
-Q2 ist nicht im Gebrauch!
Attention:
-Q2 is not used!

		Datum Date	16.05.2019		Hersteller Manufacturer	Getriebemotor Gear motor	BK-Artikel-Nr.: BK-Article-No.: 4302300	=
		Bearbeiter Edited by	gruenwald		Boll & Kirch Filterbau GmbH	Filtertyp 6.60.07/6.60.07 Alarm DP Filter type 6.60.07/6.60.07 Alarm DP		+
		Auftrag Order					Zeichnungs-Nr.: Drawing-No.: Z46603	Blatt Page 5
Revision Modification	Bearbeiter Edited by	Datum Date	Vorgang Process					von of 15

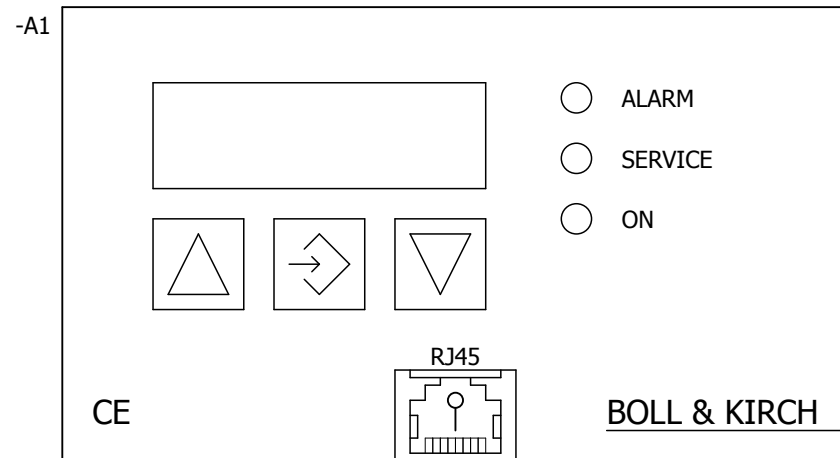

		Datum Date	16.05.2019		Hersteller Manufacturer	Bedienfeld Control panel	BK-Artikel-Nr.: BK-Article-No.: 4302300	=
		Bearbeiter Edited by	gruenwald		Boll & Kirch Filterbau GmbH	Filtertyp 6.60.07/6.60.07 Alarm DP Filter type 6.60.07/6.60.07 Alarm DP		+
Revision Modification	Bearbeiter Edited by	Datum Date	Vorgang Process				Zeichnungs-Nr.: Drawing-No.: Z46603	Blatt Page 6 von of 15

-Z1

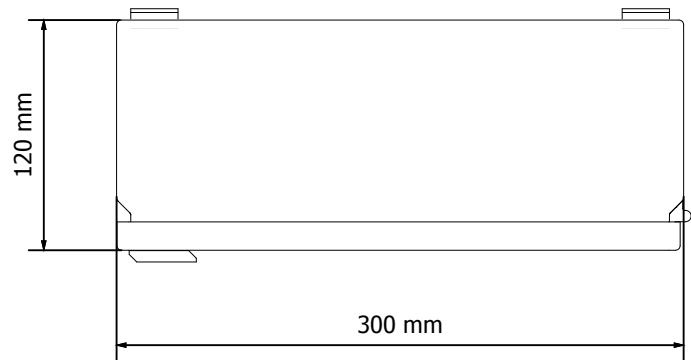
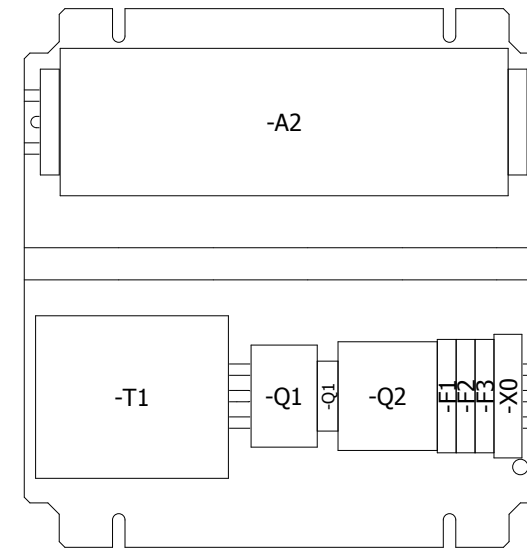
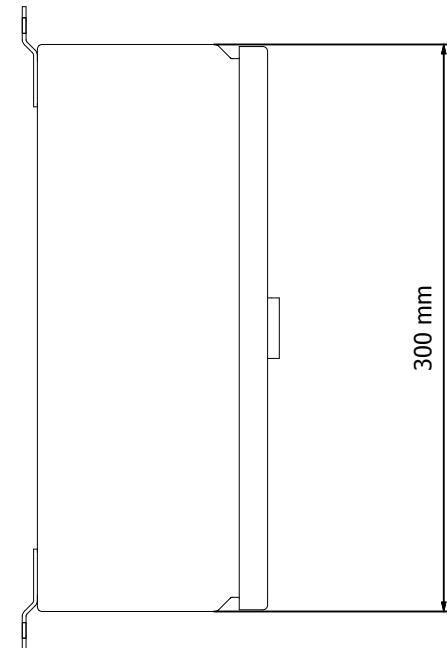
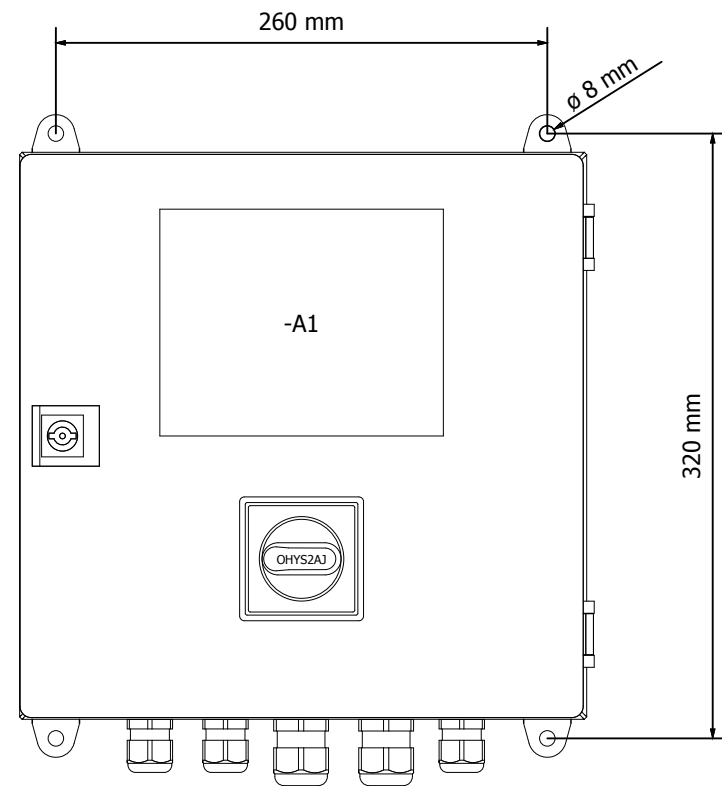
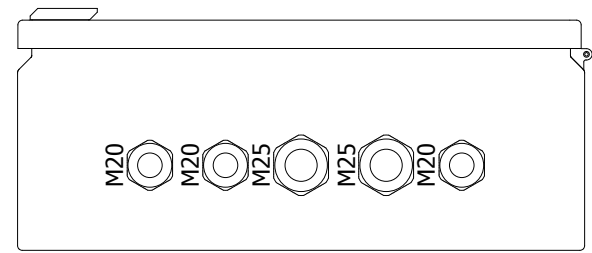

			Datum Date	16.05.2019		Hersteller Manufacturer	Aufbauplan Assembling diagram	BK-Artikel-Nr.: BK-Article-No.:	4302300	=	
			Bearbeiter Edited by	gruenwald		Boll & Kirch Filterbau GmbH	Filtertyp 6.60.07/6.60.07 Alarm DP Filter type 6.60.07/6.60.07 Alarm DP	Zeichnungs-Nr.: Drawing-No.:	Z46603	+	
			Auftrag Order							Blatt Page	7
Revision Modification	Bearbeiter Edited by	Datum Date	Vorgang Process							von of	15

Materialliste

Part list

Nr. No.	BMK DT	Anzahl Quant.	Bezeichnung Designation	Hersteller Manufacturer	Typ Type	Beschreibung Description	BK-Artikel-Nr.: BK-Article-No.:
1	-A1	1	Display	BOLL & KIRCH	BK2300	2 zeiliges universelles Display 2 lined universal Display	4300706
2	-A1	1	Patchkabel Patch cable	Reco	SFTP	Doppelt geschirmt, 0,5m, RJ 45, cat 6, gerade - gewinkelt Double shielded, 0,5m, RJ 45, cat 6, straight - angled	4100308
3	-A2	1	E/A-Modul I/O-Modul	BOLL & KIRCH	BK2300	IN 20VAC, 6DI, 5 Relaisausgänge, 3 Ventilausgänge, Steuerung für BK2300 IN 20VAC, 6DI, 5 Relay outputs, 3 Valve outputs, Control for BK2300	4300706
4	-A2-F1	1	Schmelzsicherung Safety fuse	ESKA	522.516	0,8A, 5x20mm, Träge 0,8A, 5x20mm, Passive	4200162
5	-A2-F2	1	Schmelzsicherung Safety fuse	ESKA	522.520	2A, 5x20mm, Träge 2A, 5x20mm, Passive	4200163
6	-F1	1	Sicherungsklemme Fused terminal	Conta-Clip	SIK 10/Z BG	10 mm², NS35, Beige, Schraubanschluss 10 mm², NS35, Fawn, Screw terminal	4200526
7	-F1	1	Schmelzsicherung Safety fuse	ESKA	632.717	1A, 6,3x32mm, Träge 1A, 6,3x32mm, Passive	4200146
8	-F2	1	Sicherungsklemme Fused terminal	Conta-Clip	SIK 10/Z BG	10 mm², NS35, Beige, Schraubanschluss 10 mm², NS35, Fawn, Screw terminal	4200526
9	-F2	1	Schmelzsicherung Safety fuse	ESKA	632.717	1A, 6,3x32mm, Träge 1A, 6,3x32mm, Passive	4200146
10	-F3	1	Sicherungsklemme Fused terminal	Conta-Clip	SIK 10/Z BG	10 mm², NS35, Beige, Schraubanschluss 10 mm², NS35, Fawn, Screw terminal	4200526
11	-F3	1	Schmelzsicherung Safety fuse	ESKA	632.717	1A, 6,3x32mm, Träge 1A, 6,3x32mm, Passive	4200146
12	-Q1	1	Haupt-/Not-Aus-Schalter Main / Emergency stop switch	ABB	OT16F3	3 Polig, 16A, Bodenbefestigung 3 Core, 16A, Bottom mounting	4200149
13	-Q1	1	Hilfskontakt Auxiliary contact	ABB	OA1G10	1NO, seitlich, für OT16...OT125 Hauptschalter, bis 16A 1NO, side mounting, for OT16...OT125 Main switch, to 16A	4200149
14	-Q1	1	Hauptschaltergriff Main switch handle	ABB	OHYS2AJ	für Hauptschalter OT16...125F, Rot/Gelb, IP65, NEMA 1 for Main switch OT16...125F, Red/Yellow, IP65, NEMA 1	4200149
15	-Q1	1	Hauptschalterwelle Main switch shaft	ABB	OXS6X95	für Hauptschalter OT16...125F, 95mm lang for Main switch OT16...125F, 95mm long	4200149
16	-Q2	1	Leistungsschutz Power contactor	ABB	BC6-30-10	4kW, 1NO, 24VDC, Schraubanschluss 4kW, 1NO, 24VDC, Screw connections	4200148
17	-T1	1	Steuertransformator Control transformer	MDEXX	TAM3496-0EJ00-0FA2	einphasig, 65VA, IN 220-550VAC, OUT 20VAC 220VAC 24VDC, 50/60Hz, IP00, Schraubanschluss single-phase, 65VA, IN 220-550VAC, OUT 20VAC 220VAC 24VDC, 50/60Hz, IP00, Screw terminal	4200524
18	-X0	2	Schutzleiterklemme Protective conductor terminal	Phoenix Contact	UT 2,5-QUATTRO-PE	4mm², NS35, Grün/Gelb, Schraubanschluss 4mm², NS35, Green/Yellow, Screw connections	4100073
19	-Z1	1	E-Box	Rittal	EB 1555.500	300 x 300 x 120mm, Stahl, RAL7035, 1 Türieg, Bearbeitet 300 x 300 x 120mm, Steel, RAL7035, 1 Door, Edited	4306540
20	-Z1	4	Wandbefestigungshalter Wall mounting bracket	Rittal	KL 1590.000	Stahlblech verzinkt, Wandabstand 8 mm Carbon steel zinc-plated, Projection 8 mm	4507593

		Datum Date	16.05.2019		Hersteller Manufacturer	Materialliste Part list	BK-Artikel-Nr.: BK-Article-No.:	4302300	=	
		Bearbeiter Edited by	gruenwald		Boll & Kirch Filterbau GmbH	Filtertyp 6.60.07/6.60.07 Alarm DP Filter type 6.60.07/6.60.07 Alarm DP	Zeichnungs-Nr.: Drawing-No.:	Z46603	+	
		Auftrag Order							Blatt Page	8
Revision Modification	Bearbeiter Edited by	Datum Date	Vorgang Process						von of	15

Materialliste

Part list

Nr. No.	BMK DT	Anzahl Quant.	Bezeichnung Designation	Hersteller Manufacturer	Typ Type	Beschreibung Description	BK-Artikel-Nr.: BK-Article-No.:
21	-Z1	3	Kabelverschraubung Cable gland	WISKA	EMSKV 20-25 EMV-Z	M20, Messing, vernickelt, EMV-fest, Kabeldurchmesser 9-17mm M20, Brass, nickel-plated, EMC-proof, Cable diameter 9-17mm	4100097
22	-Z1	3	Gegenmutter Locknut	WISKA	EMMU 20	M20, Messing, vernickelt M20, Brass, nickel-plated	4100309
23	-Z1	2	Kabelverschraubung Cable gland	WISKA	EMSKV 25-32 EMV-Z	M25, Messing, vernickelt, EMV-fest, Kabeldurchmesser 13-21mm M25, Brass, nickel-plated, EMC-proof, Cable diameter 13-21mm	4100098
24	-Z1	2	Gegenmutter Locknut	WISKA	EMMU 25	M25, Messing, vernickelt M25, Brass, nickel-plated	4100310
25	-Z1	3	Reduzierdichteinsatz Reduced seal insert	WISKA	RDE 25	Kabeldurchmesser 7-12mm, für M25 Kabelverschraubung Cable diameter 7-12mm, for M25 Cable gland	3250001
26	-Z1	2	Reduzierdichteinsatz Reduced seal insert	WISKA	RDE 32	Kabeldurchmesser 9-14mm, für M32 Kabelverschraubung Cable diameter 9-14mm, for M32 Cable gland	3250002
27	-Z1	2	Endwinkel End angle	Conta-Clip	ZES 35/2 BG	Beige, für NS35 Tragschiene Fawn, for NS35 Mounting rail	4100311

			Datum Date	16.05.2019		Hersteller Manufacturer	Materialliste Part list	BK-Artikel-Nr.: BK-Article-No.:	4302300	=	
			Bearbeiter Edited by	gruenwald		Boll & Kirch Filterbau GmbH	Filtertyp 6.60.07/6.60.07 Alarm DP Filter type 6.60.07/6.60.07 Alarm DP	Zeichnungs-Nr.: Drawing-No.:	Z46603	+	
			Auftrag Order							Blatt Page	9
Revision Modification	Bearbeiter Edited by	Datum Date	Vorgang Process							von of	15

Klemmenplan Terminal diagram

Funktionstext Function text	Kabelname Cable name	Kabeltyp Cable type	= + # - X2 Filter Filter							Kabelname Cable name	Kabeltyp Cable type
			Ziel Target		Klemme Terminal	Brücke Jumper	Quelle Source		Blatt Page Pfad Path		
			Bezeichnung Designation	Anschluss Connection			Bezeichnung Designation	Anschluss Connection			
Differenzdruck DP 75% Differential pressure DP 75%			-A2	40	1			1	1		
Differenzdruck DP 75% Differential pressure DP 75%			-A2	39	2			2	1		
Differenzdruck zu Hoch DP 100% Differential pressure too High DP 100%			-A2	38	3			1a	1		
Differenzdruck zu Hoch DP 100% Differential pressure too High DP 100%			-A2	37	4			3a	1		
Endschalter S2Q Limit switch S2Q			-A2	32	5			2	1		
Endschalter S2Q Limit switch S2Q			-A2	31	6			3	1		
Spülventil Flushing valve			-Y1	x1	7		-A2	8	1		
Spülventil Flushing valve			-Y1	x2	8		-A2	9	1		
Kammerventil Chamber valve			-Y2	x1	9		-A2	10	1		
Kammerventil Chamber valve			-Y2	x2	10		-A2	11	1		
Nachblaseventil Afterblowing valve			-Y3	x1	11		-A2	12	1		
Magnetventil Solenoid valve			-Y3	x2	12		-A2	13	1		
Differenzdruckanzeiger ΔP Spülölaufbereitung Differential pressure indicator			-A2	36	13			1a	1		

			Datum Date	16.05.2019		Hersteller Manufacturer	Klemmenplan Terminal diagram	BK-Artikel-Nr.: BK-Article-No.:	4302300	=	
			Bearbeiter Edited by	gruenwald		Boll & Kirch Filterbau GmbH	Filtertyp 6.60.07/6.60.07 Alarm DP Filter type 6.60.07/6.60.07 Alarm DP	Zeichnungs-Nr.: Drawing-No.:	Z46603	+	
			Auftrag Order							Blatt Page	14
Revision Modification	Bearbeiter Edited by	Datum Date	Vorgang Process							von of	15

Klemmenplan Terminal diagram

Funktionstext Function text					Kabelname Cable name	= + # - X2 Filter Filter						Kabelname Cable name					
						Kabeltyp Cable type	Ziel Target		Klemme Terminal	Brücke Jumper	Quelle Source					Blatt Page Pfad Path	
							Bezeichnung Designation	Anschluss Connection			Bezeichnung Designation						Anschluss Connection
Differenzdruckanzeiger ΔP Spülölaufbereitung Differential pressure indicator						-A2	35	14		3a	1						
								PE	•		1						
								PE	•		1						
								PE	•		1						
								PE	•		1						

			Datum Date	16.05.2019		Hersteller Manufacturer	Klemmenplan Terminal diagram	BK-Artikel-Nr.: BK-Article-No.:	4302300	=	
			Bearbeiter Edited by	gruenwald		Boll & Kirch Filterbau GmbH	Filtertyp 6.60.07/6.60.07 Alarm DP Filter type 6.60.07/6.60.07 Alarm DP	Zeichnungs-Nr.: Drawing-No.:	Z46603	+	
			Auftrag Order							Blatt Page	15
Revision Modification	Bearbeiter Edited by	Datum Date	Vorgang Process							von of	15